

PSx-1-240-B

FKK Corporation

Wood pellet and biomass system ceramic igniter

Specification Data

Product name: Ceramic Igniter PSx-1-240-B

Drawing number: IBA-HH006B

Revised on: 2020.02.01



1. Application

This engineering specification data applied to ceramic igniter, which is used for the ignition of biomass (especially wood pellet) burning system. It can also be adapted to other specific application (biofuel system, water boiling, industrial oven, etc).

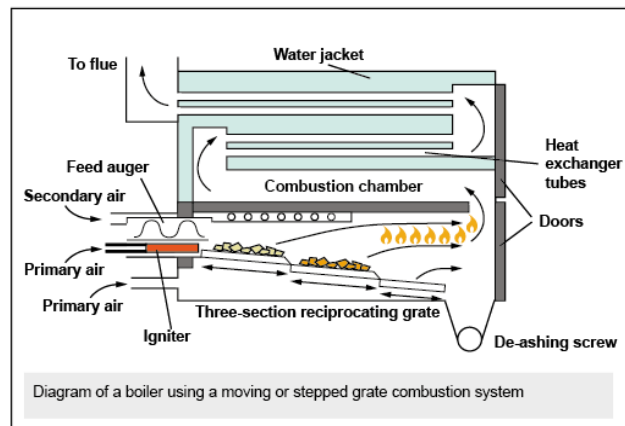
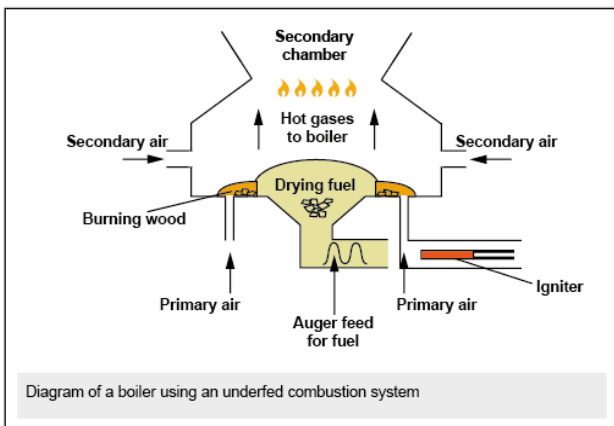
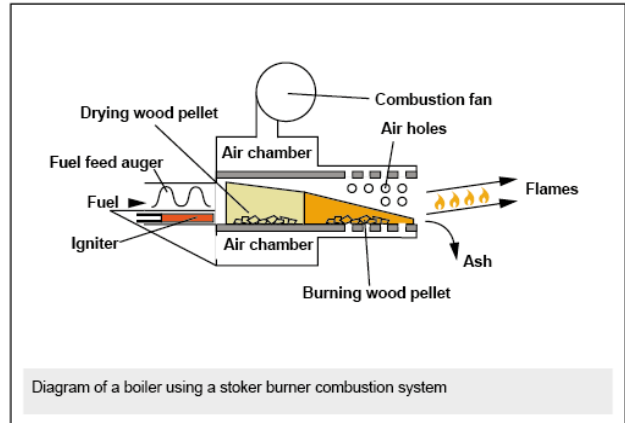
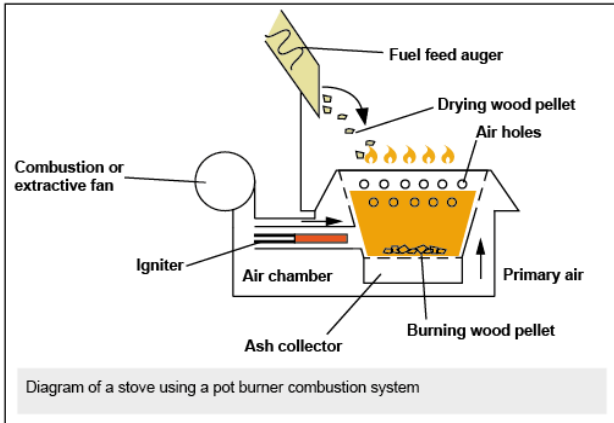

2. Part Number

Part number PSx-1-240-B	
Product type	PSx: Pellet System X
Flange, fitting type	1: Ceramic flange 26mm type
Voltage	240: AC 220~240V
Heating element type	B: Black heating element type (=300W class)

3. Materials

Numbers refer to related drawing parts list.

- | | |
|--------------------------------|--|
| 1. Heating element LCR-PL-240V | Metalized Alumina Al ₂ O ₃ 92%
Dimension: $\varnothing 11.55 \times 106$ L
Nominal resistance 40.15~49.13 Ω (at $23\pm 1^{\circ}\text{C}$)
Dissipation pattern: in-line |
| 2. Lead wires | Nissei Electric RS-GE 0.5sq White
Heat resistance: 180°C |
| 3. Heat shrinkable tube | Nissei Electric Silicon heat shrinkable tube
Dimension: $\varnothing 16 \times 20$ L
Heat resistance: 180°C
Breakdown voltage: minimum 6kV |
| 4. Crimp terminal connector | Nippon Electrode Splice 29071-1
Material: Copper, Tin plating |
| 5. Heat shrinkable tube | Nissei Electric Silicon heat shrinkable tube
Dimension: $\varnothing 4 \times 28$ L
Heat resistance: 180°C
Breakdown voltage: minimum 6kV |

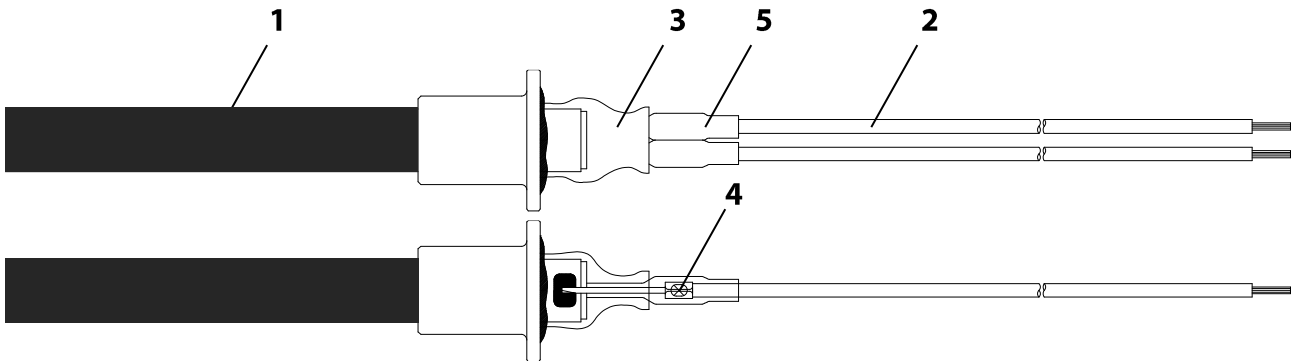

4. General properties

Properties	Value	Condition
Voltage	AC230V \pm 15%	50 / 60Hz
Power consumption	290 W (AC220V) 310 W (AC 230V) 330 W (AC 240V)	44.65 Ω in free air environment
Normal temperature resistance	40.15~49.13 Ω	23 \pm 1 $^{\circ}$ C ambient temperature
Rising time	> 820 $^{\circ}$ C within 60s, Max temperature of 1000 $^{\circ}$ C after 120s	23 \pm 1 $^{\circ}$ C ambient temperature
Inrush current	< 7.0A	
Minimum Wattage	> 280W at 230V	
Minimum temperature	870 $^{\circ}$ C	
Insulation resistance	> 50M Ω	Applied at both side of Heating element DC500V at normal temperature and humidity
Withstand voltage	Current Leakage \leq 5 mA	Applied at both side of Heating element AC 1500V for 1 s at normal temperature and humidity rate
Caulking strength (Nickel wire and lead wire)	\geq 29.4 N (over 3kg f)	The nickel wire has been clamp and the lead part has been tested with push-pull gauge.
Discontinuous conduction (heating element)	Without breaking	Applied at 264V for 4min On/5min Off (forced cooling) for over 3000 cycles

Test condition:

All values have been measured in the same condition as follow:

Temperature: 23 \pm 1 $^{\circ}$ C

Humidity rate: 25~80%

Atmospheric pressure: 101.3kPa~106kPa

Frequency: 50Hz

5.Heater application environmental condition

Temperature

	Characteristics	Unit	Minimum	Normal	Maximum
Storage	Storage temperature	°C	-40	5~35	60
Operation	Heating element (1)	°C	-40	500	800
	Ceramic flange (2)	°C	-40	200	400
	Heating element electrodes (3)	°C	-40	150	250
	Wiring assembly (4)	°C	-40	150	180

() number on below diagram

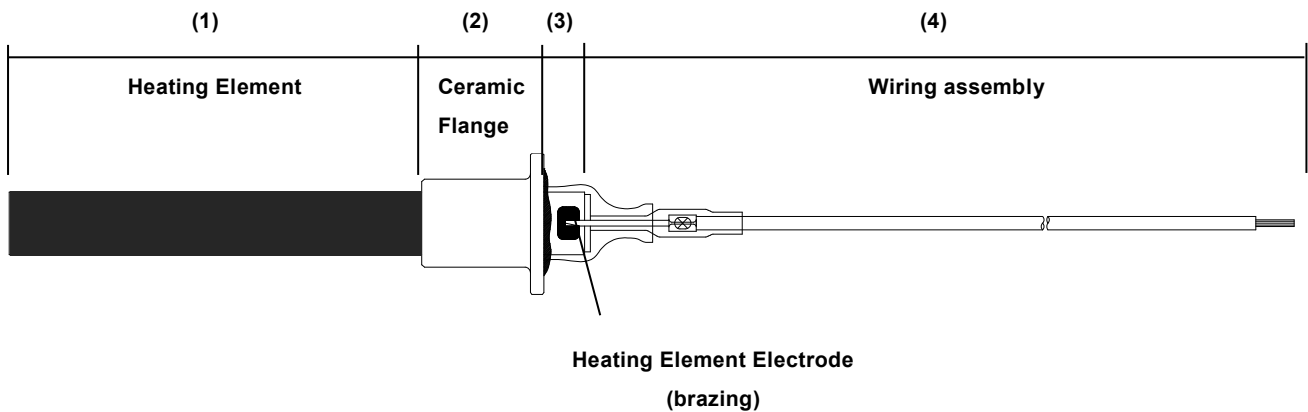

Change rate

	Characteristics	Unit	Minimum	Normal	Maximum
	Heater resistance	Ω	40.15	44.65	49.13
	Heater voltage (AC)	V	195	230	264
	Inrush current (23±1°C)	A	4.8	5.1	7.0
	Heater current (195~264V / 44.65Ω)	A	1.23	1.34	1.44
	Heater wattage (195~264V / 44.65Ω)	W	240	310	380
	Heater temperature (power ON)	°C	-	-	1000

6. Rising temperature (reference only)

Rising surface temperature varied according to forward current and nominal resistance. The graphs below show the temperatures according to forward current at the recommended resistance value. These values are for reference only.

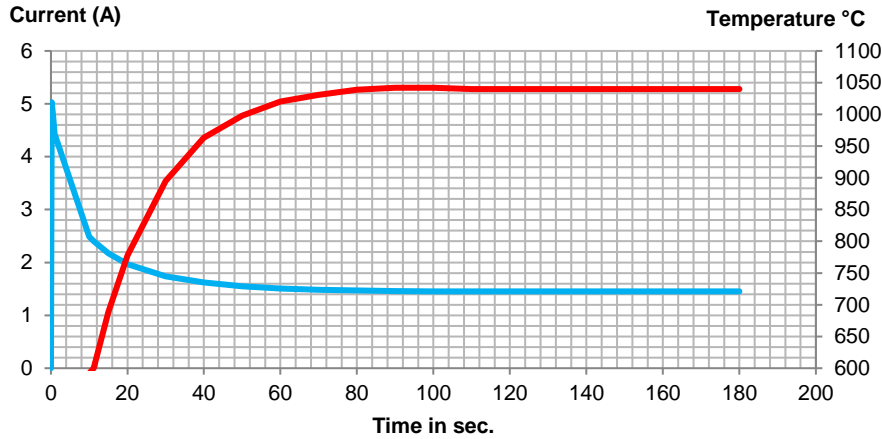

Voltage: AC240V / 60Hz
 (=max specification)
 Peak current: 5.053A
 Max temperature: 1045°C

Nominal resistance: 41.80Ω
 Emissivity (ε): 0.8
 Temperature measurement point:
 21.5mm from the tip
 Condition: temperature 23.3°C /
 humidity 54%RH

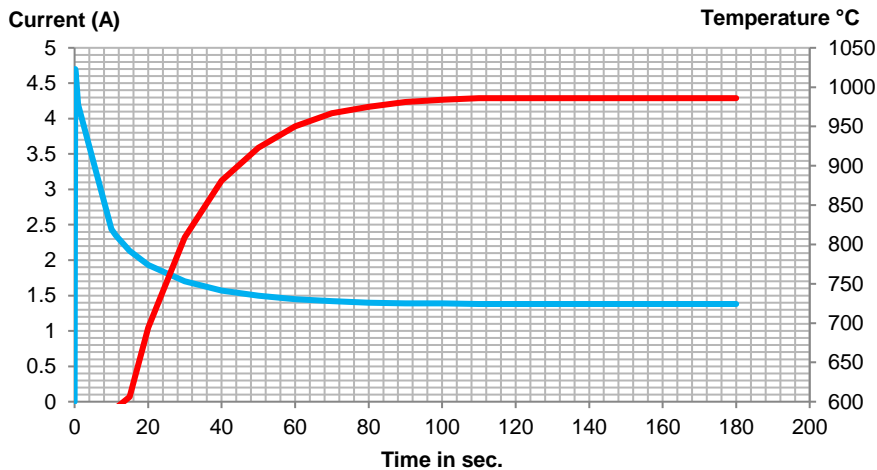

Voltage: AC216V / 60Hz
 (max specification -10%)

Peak current: 4.717A
 Max temperature: 988°C

Nominal resistance: 41.80Ω
 Emissivity (ε): 0.8
 Temperature measurement point:
 21.5mm from the tip
 Condition: temperature 23.3°C /
 humidity 54%RH

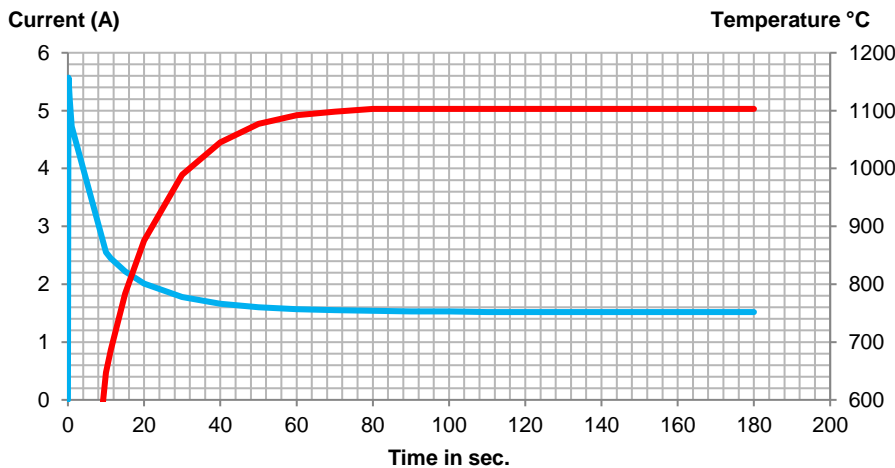

Voltage: AC264V / 60Hz
 (max specification +10%)
 Peak current: 5.572A
 Max temperature: 1106°C

Nominal resistance: 41.80Ω
 Emissivity (ε): 0.8
 Temperature measurement point:
 21.5mm from the tip
 Condition: temperature 23.3°C /
 humidity 54%RH

7. Durability test (reference only)

<p>Discontinuous conduction (Heating element)</p>	<p>Without breaking and substantial deterioration of properties</p>	<p>Applied at 264V for 4 min On / 5 min off (Forced cooling) for over 3,000 cycles.</p> <p>Applied at 240V for 60 Sec ON, 180 Sec OFF for over 100,000 cycles.</p> <p>Condition: temperature 23.3°C / humidity 54%RH, ambient air Values for reference only.</p>
---	---	--

60 sec ON, 180 sec OFF cycle reliability test

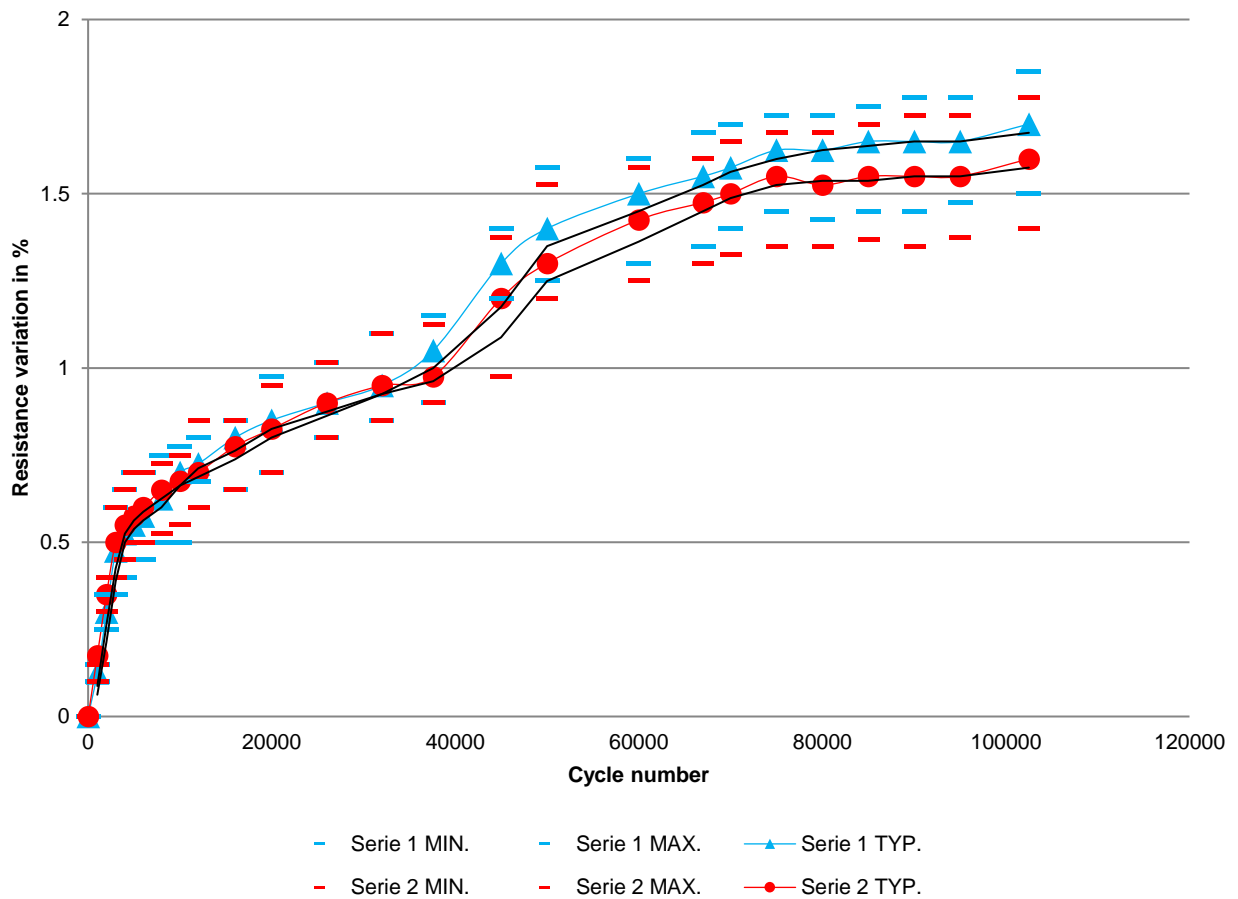

8. Requirement of heater installation condition

For optimal ignition performance and a long lifetime of the igniter's heating element, please read carefully the following installation requirements and notices.

Operating temperature

After the installation position is decided, the operating temperature of the heater should be measured and each temperature must be within the recommended range defined in the "Heater application environmental condition" section of the present document.

Recommended design

To ensure a good protection of the heater we recommend designing a protection tube as follow:

The protection of the heater from breaking should be ensured by a metal tube (iron or stainless steel, thickness $\geq 2\text{mm}$ recommended). We recommend to use preferably iron.

The steel protection tube shall let a distance of minimum 3mm around the ceramic heating element. If not respected this could lead to local overheating of the interspace between the steel tube and the heating element, leading to damage it or substantially reducing the rating life of the igniter.

Please avoid direct contact of the ceramic heating element with the protective tube, or solid fuel or ashes. All contact should be strictly avoid.

The heater reach a steady-state temperature of about $950\sim 1050^{\circ}\text{C}$. For a long lifespan, forced cooling by air blower is not necessary but you should ensure a sufficient stream (stream flow $\geq 0.2\sim 2\text{m}^3/\text{min}$) of ambient temperature air to avoid overheating.

The air stream and protective tube shape should be considered not to collect ashes and material from solid fuel combustion residues.

The heater should not be constantly exposed to fire. This could lead to corrosion of the heating element and shorten the life time.

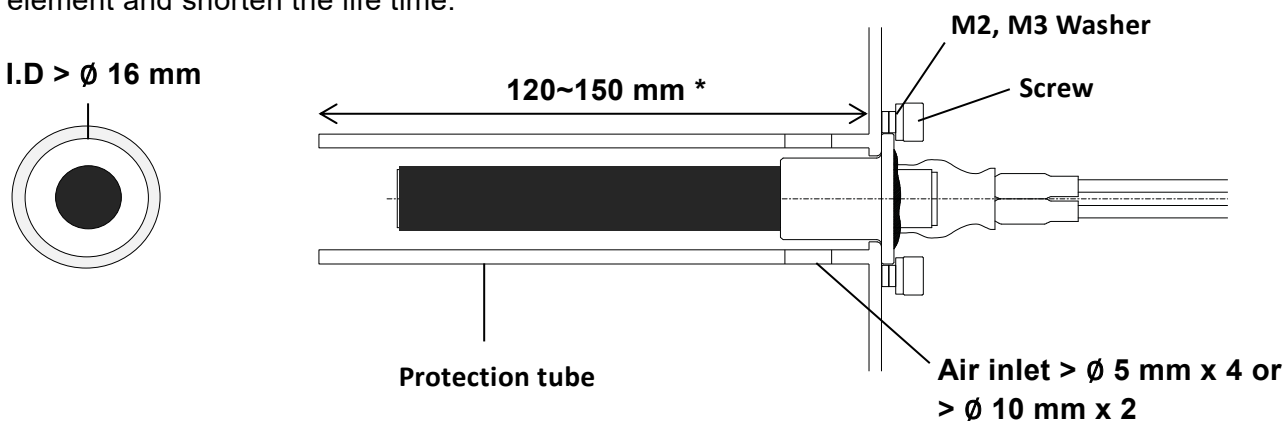

* depend on air stream and burner size

Special recommendation

Introducing a cleaning stage in the automatic ignition program of the controller board can optimized the performance and rated life of the igniter. A simple cleaning stage, with for instance, fan blower at high speed for 30 seconds before ignition phase, can ensure that the protective tube and heater always remain clean from ashes and other combustion residues.

Installation prohibition

Please design your system in order that the heating element of the heater never enters directly in contact with solid fuel or ashes or metal protective tube. If the heating element enters in contact with solid fuel, ashes or metal protective it could damage the heating element. Longer protective tube should be consider to avoid this situation.

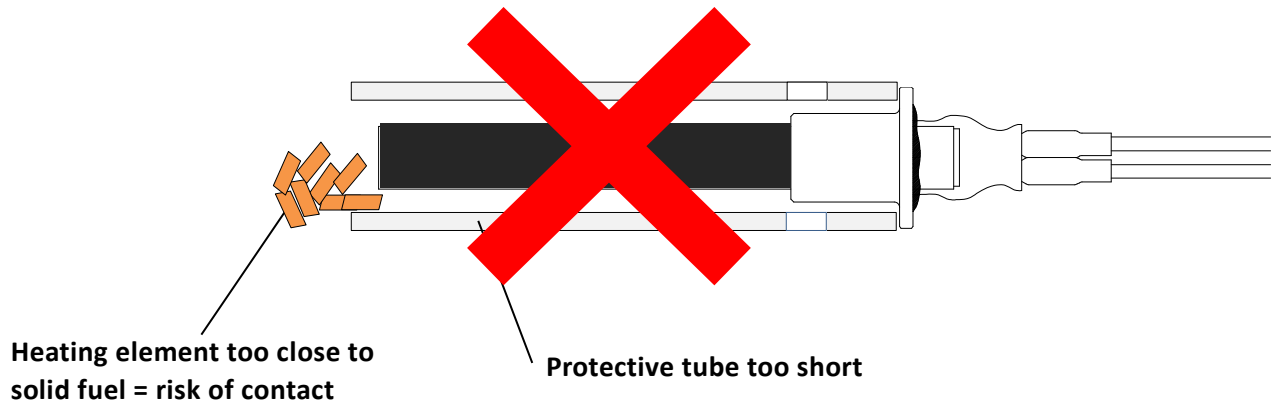

Attachment system should be consider to avoid this situation.

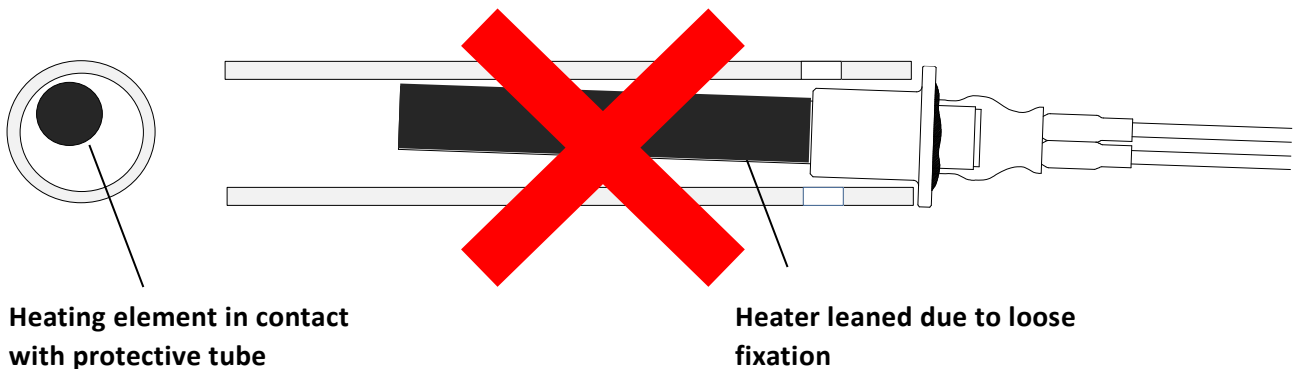

Please make sure to let an interspace of minimum 3mm around the ceramic heating element and the tube.

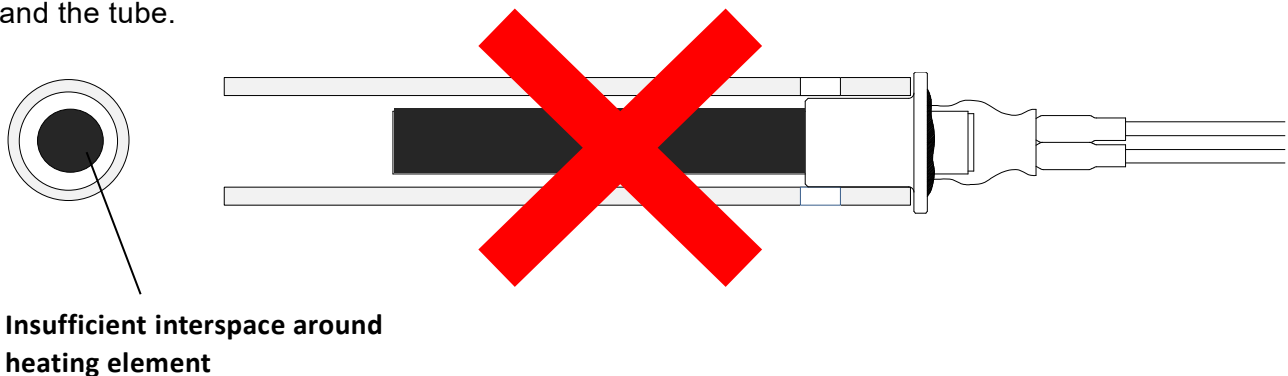

Other installation prohibition

- You should avoid to install the product in a confined environment without air stream, overheat could damage the heating element. While the power is on, please ensure a sufficient flux of ambient temperature air (stream flow $\geq 0.3 \sim 0.7 \text{m}^3/\text{min}$ recommended).
- Environmental temperature of the heater electrode (brazing portion of the metal heater leads), should be maintain at less than 250°C and heating element at less than 800°C .
- Do not install the heater in environment, which can gather can gather condensed water or be water or oil splashed. In this condition, crack may happen in the heating element.
- The heater ceramic heating element and flange should be free from harmful contamination. Harmful contamination (ashes, grease, combustion residues) may cause crack or electrical failure.
- Do not cool too suddenly the heater. Thermal shock crack may occur in the heating element. We strongly recommend starting the system fan before powering on the heater.
- The wiring assembly part protected by heat shrinkable tube (cf. (1) below figure) should not be bent over 60 degree angle tensile.
- The curvature of lead wire part (cf. (2) below figure) must be larger than R20.

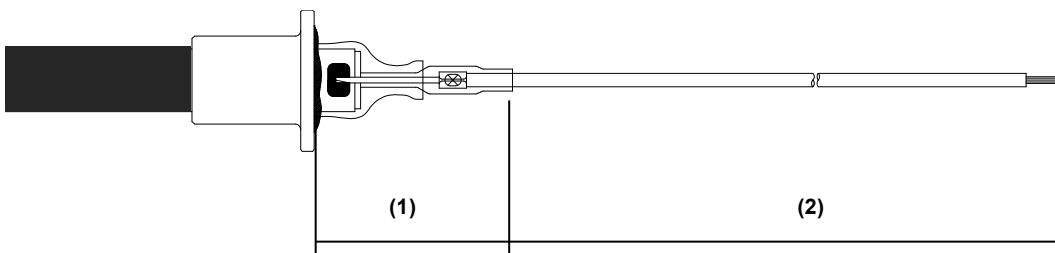

- Large tensile stress of lead wire must not be keep in the operation condition. After being installed, the lead wire must be free from tensile stress.
- In order to prevent body injuries or serious damage, you should ensure to design a safety environment to place this product, taking in count a possible failure of this component.

9. Handling precautions and prohibitions

The following items may seriously affect the rated life and properties of this product.

- Do not input inappropriate forward current. Applying a DC current may cause the deterioration of the ion transfer and degradation of resistance or disconnection.
- Please avoid colliding ceramics pieces each other.
- Please avoid colliding or giving excessive shock to ceramic part (drop down from more than 30 cm height). This could crush or crack the ceramic heating element and break it while powering on. Do not hold the heater by the wiring side only. This handling may cause to hit the heater ceramic element against the operation desk, the rack, the wall, etc. Then the ceramic may be cracked. Please always handle the products with care.
- When the heater is install, the heater should be install by hand. It is not permit to tighten or fix the heater by spinning connector or the lead wire only. This action will make a twisted wire, and then it may cause a disconnection or lead wire insulation failure.

PSx-1-240-B

This product specification data guarantees the whole product as well as the part. Please contact our company for specific usage or conditions. Please inform us if you want to make modification to the product. All modification made to the product occurring after the delivery would be consider as outside the scope of the present specification data and the warranty.

10.Storage

The heater should be carried and store in FKK blister case until installation in the burner. If the heaters are stored in FKK package, be careful to handling with care. The heater can get damages by wetting, impact by dropping, stacking or mechanical shock etc.

Storage in the below conditions should be avoided:

- Sea breeze, C12, H2S, NH3, SO2, NOX environment
- Exposition to direct sunlight
- Long storage in moist and oily condition or in conditions other than 5~35°C normal storage temperature and 45~85% of normal storage humidity

11.Warranty

FKK Corporation warrants that Products delivered by FKK Corporation are free from defects in material and workmanship in accordance with the respective state-of-the-art at the time of delivery.

Complaints for defects have to be notify to FKK Corporation in writing within 14 days of the receipt of the Products, or with respect to hidden defects which could reasonably not have been detected upon receipt of the Products within 14 days of the detection of such hidden defect. If nothing to the contrary has been agreed in writing, a warranty period of 24 months from shipment date applies.

Subject to timely notice, the warranty is fulfilled at the discretion of FKK by a replacement delivery or elimination of the fault at no charge.

The warranty is valid on condition that the customer contacts FKK Corporation during the warranty period and provide all details about the failure (pictures, installation check-list,RMA form, etc.). The complaint will then undergo a reviewing process. Once the complaint is found to be legitimate, the product can be returned to FKK Corporation in Japan. The transport costs (DDP - delivered duty paid) for the return shipment in cases of warranty must be borne by the buyer.

No warranty applies in the following cases:

- Non observance of data sheet installation requirement
- Overloading, inappropriate use or handling
- Damage caused during the delivery
- Repair and modification made by other company than FKK Corporation
- Damaged caused during natural disaster, fire, etc.
- Damage due to natural wear

PSx-1-240-B

The warranty is limited to the purchase price of the product only. It does not cover any transport costs, labor or consequential loss or damage. FKK Corporation will not be held liable for any loss or damages of whatsoever nature, whether directly or indirectly, sustained by the purchaser arising from the use or defect of this product.

In case of damaged product, please advise with your FKK sales representative or distributor.

12. Serial number marking

All products are marked with a serial number representing the year and month of production.

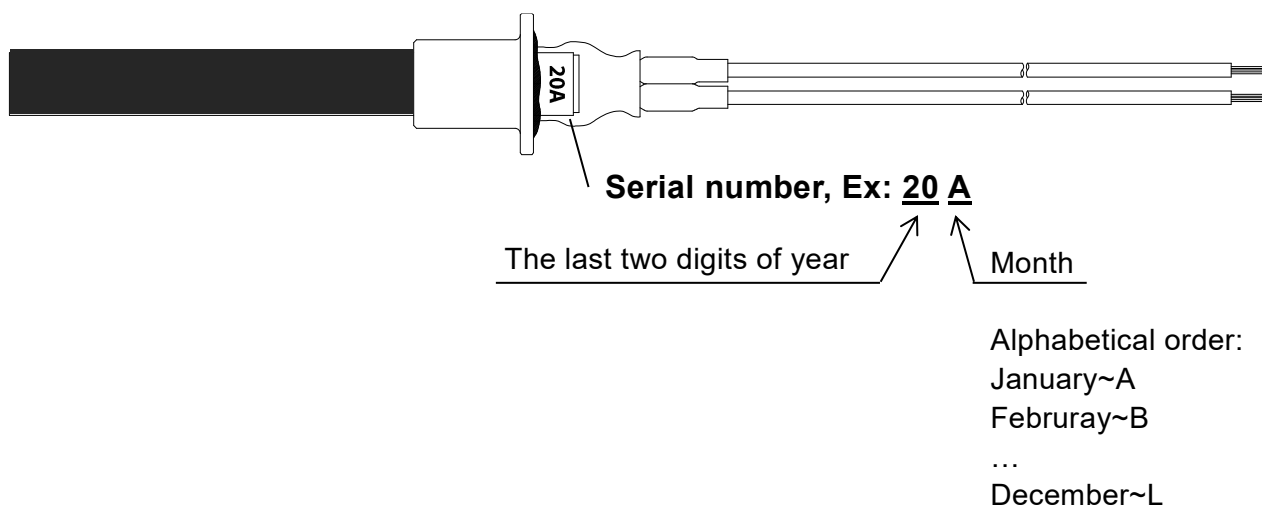

13. Conformity with EC regulation

This product complies with European community regulations as follow:

- 1907/2006/EC European Directive of June 2006 on Registration, Evaluation, Authorization and Restriction of Chemicals in Electrical and Electronic Equipment (REACH).
- 2011/65/EU European Directive of June 2011 on Restriction of the use of Certain Hazardous Substances in Electrical and Electronic Equipment (RoHS).
- 2006/95/EC European Directive of December 2006 on electrical equipment designed for use within certain voltage limits (LVD).

*Related standards : EN60335-1-45, EN60335-2-45

This product has been checked and certified fully compliant to EC regulation by TUV Rheinland certification company (test report No:50031010001 and 0144065711a001) and TUV Sud certification company ((test report No: 6840219086601 and 73577629-001-000)



14.Revision history

Specification sheet number		Drawing number	IBA-HH006B		
Customer company name		Designated product	PSx-1-240-B		
Specification sheet number	Revised date	Content of revision			Author
		Page number	Item name	Content	
	2013/11/10	all	all	Creation	M.S
	2013/12/01	all	all	Minor revision of text	M.S
	2014/03/15	all	all	Minor revision of text	M.S
	2014/08/10	all	all	Minor revision of text	M.S
	2015/12/20	all	all	Minor revision of text	M.S
	2017/09/01	all	all	New heating element	M.S
	2020/02/01	all	all	Minor revision of text	M.S

15.Information

For use beyond typical operating conditions or applications, please consult your FKK sales representative or distributor for further information.

The products digital data-sheet and drawing can be downloaded on FKK web site or by scanning the QR code below.



Data-sheet



Drawing

About FKK

FKK Corporation (Fuji Kogyo Kabushiki) was incorporated in 1954 and since then producing ignition components for gas, oil and biomass sector. The company complies with ISO 9001 and ISO 14001.



TUV® Certification number:

ISO 9001: 1210057985 TMS

ISO 14001: 1210457985 TMS

For more information about FKK and our products, please visit www.plug.fkk-corporation.com

©2020 FKK Corporation. All right reserved.